

Guia de Instalação IPMH610E

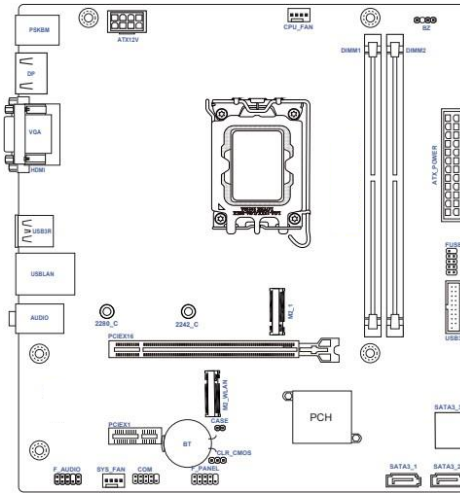

Visão Geral	
CPU	LGA1700 soquete, suporta processador Intel® 12ª geração Core™
Chipset	Intel® H610
Memória	Arquitetura de memória Dual-Channel DDR4 2x 288-pin DDR4 Long DIMM soquetes com suporte para até 64 GB Suporta SDRAM DDR4 3200 MHZ
Slots de Expansão	1x PCI Express x16 Gen4 slot 1x PCI Express x1 Gen3 slot 2x M.2 Slots (Type 2242/2280) - 1x PCIe1x Gen2 WiFi/BT/CNVi (By PCH) - 1x PCIe4x Gen3/SATA SSD (By PCH) - By switch IC ASM1480
Rede	Realtek 1GbE RTL8111H-CG Controller
Storage	Suportado pelo Intel® H610 Express Chipset - 4x Serial ATA 6Gb/s
Áudio	Realtek ALC897+Anpec2609 (Opcional) High Definition Audio CODEC
USB 3.2	Total: 3 portas 2 portas no painel traseiro 1 porta onboard (opcional via cabo)
USB 2.0	Total: 3 portas 2 portas no painel traseiro 1 portas onboard (opcional via cabo)
Dispositivo de Alarme	Buzzer onboard
Painel Traseiro	1x porta PS2 - conector mouse e teclado 1x porta DP 1x porta D-sub (porta VGA) 1x porta HDMI 2x porta USB 3.2 Gen2x1 (Type A) 1x conector RJ45 LAN 2x porta USB 2.0 1x canal Audio 6 (line-in, line-out, microfone)
Conectores	
Conectores internos	1x 24-pin ATX Power Supply conector
	1x 8-pin ATX 12V Power conector
	1x 4-pin CPU_FAN conector
	1x 4-pin SYS_FAN conector
	1x USB 3.2 Gen1x1 header supports additional two USB 3.2 Gen1x1 ports
	1x 5x2 pin USB 2.0 header supports additional two USB 2.0 ports
	4x SATA 6Gb/s connectors
	1x Front Panel audio header
	1x Front Panel switch/LED header
	1x COM header
	1x Clear CMOS jumper
	1x 4-pin Buzzer header(black)
1x Case open header	
1x SPKR header (Opt.)	
Outros	
Formato	Micro ATX 229 mm x 213 mm
BIOS	AMI BIOS 128 Mb

Layout Motherboard



Portas I/O

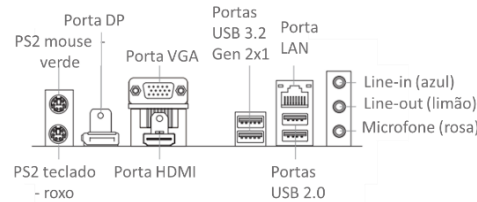

Jumper

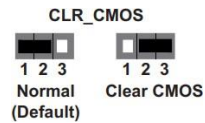

LAN LED Indicators

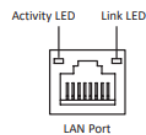

LAN LED	STATUS	Descrição
Atividade LED	Desligado	Sem dados
	Amarelo piscante	Ativo
Link LED	Desligado	Sem link
	Verde	Link (Giga/100 port)
	Laranja	Link (10 port)

Pinos Definições

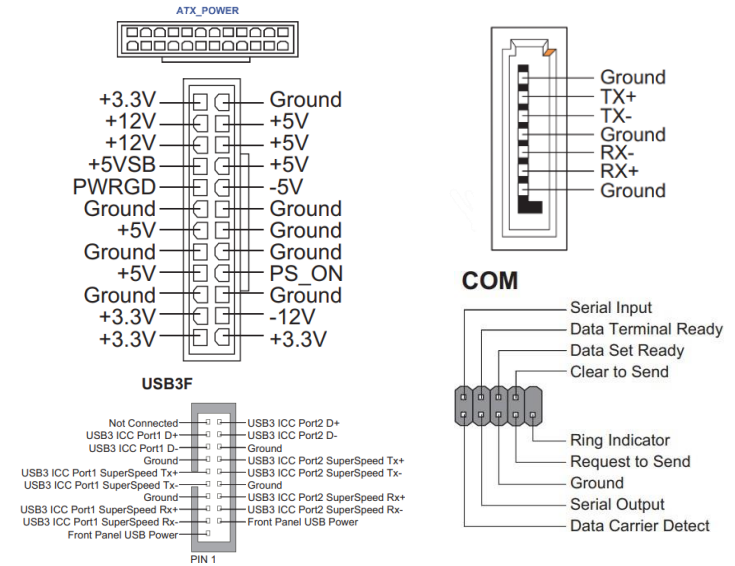

FUSB

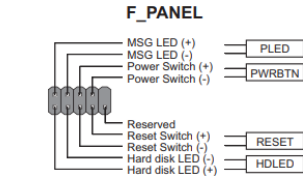
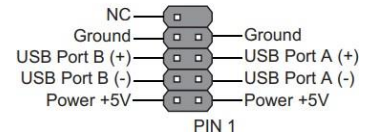

F_AUDIO

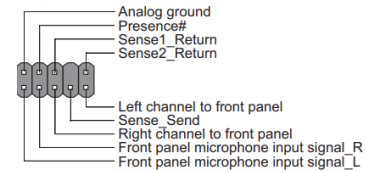

CASE



CPU_FAN

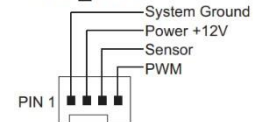

SYS_FAN2

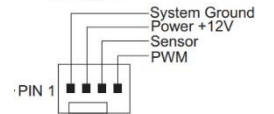

PRODUZIDO NO
POLO INDUSTRIAL
DE MANAUS



Produzido por CNPJ: 84.489.988/0005-18